





SYMMONS® DS Creations

the smart choice™



SPP-3610 (CDSK0322-PO) Pull-Out Kitchen Faucet Installation Guide

| | |
|---|--|
| Model Numbers | Specification |
| <input type="checkbox"/> SPP-3610 <i>Pull-Out Kitchen Faucet</i> | <p>Pull-Out Kitchen Faucet shall include single hole mount configuration, ceramic cartridge, braided hose connections and standard 2.2 gpm (8.3 L/min) aerator. Faucet shall be made from metal construction, plated in standard polished chrome finish.</p>  |
| Modifications | Warranty |
| <input type="checkbox"/> -STN <i>Satin Nickel finish</i> <input type="checkbox"/> -STS <i>Stainless Steel finish</i> Note: Append appropriate -suffix to model number. | <p>Limited Lifetime - to the original end purchaser in consumer/residential installations. 5 Years - for industrial/commercial installations. Refer to www.symmons.com/warranty for complete warranty information.</p> |
| Compliance -ASME A112.18.1/CSA B125.1 -NSF/ANSI 61.9, NSF/ANSI 372  | |

Dimensions

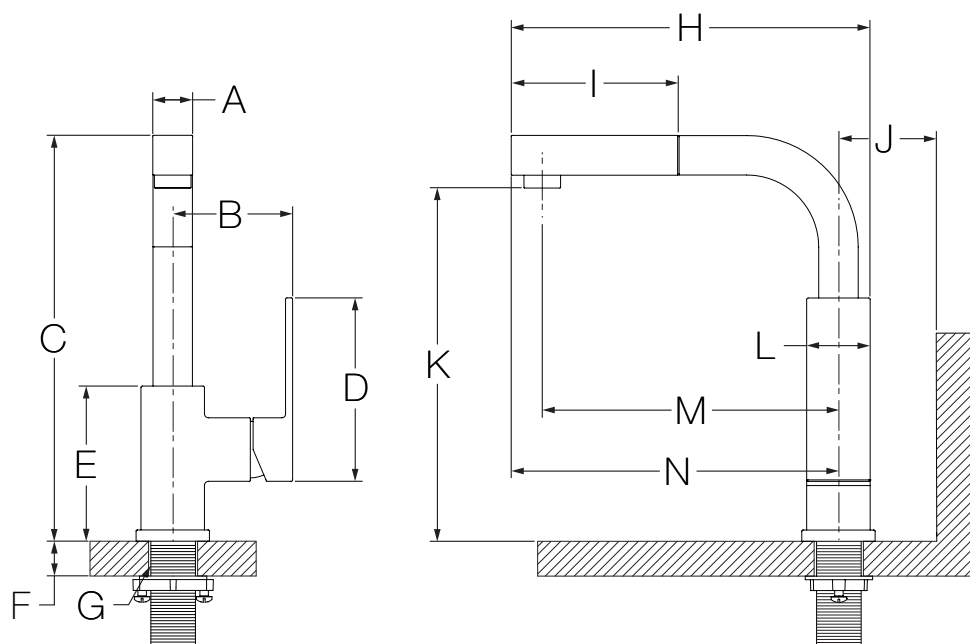





| Measurements | |
|--------------|---|
| A | 1-1/8", 29 mm |
| B | 3-3/8", 86 mm |
| C | 11-5/16", 287 mm |
| D | 5-1/8", 130 mm |
| E | 4-5/16", 110 mm |
| F | Deck Thickness Ref. Max. 2-1/2", 64 mm |
| G | Hole Size Min. Ø 1-3/8", 35 mm Max. Ø 1-1/2", 38 mm |
| H | 10", 254 mm |
| I | 4-5/8", 117 mm |
| J | To Backsplash 4", 102 mm |
| K | 9-7/8", 251 mm |
| L | 1-3/4", 44 mm |
| M | 8-1/4", 210 mm |
| N | 9-1/8", 232 mm |

Notes:

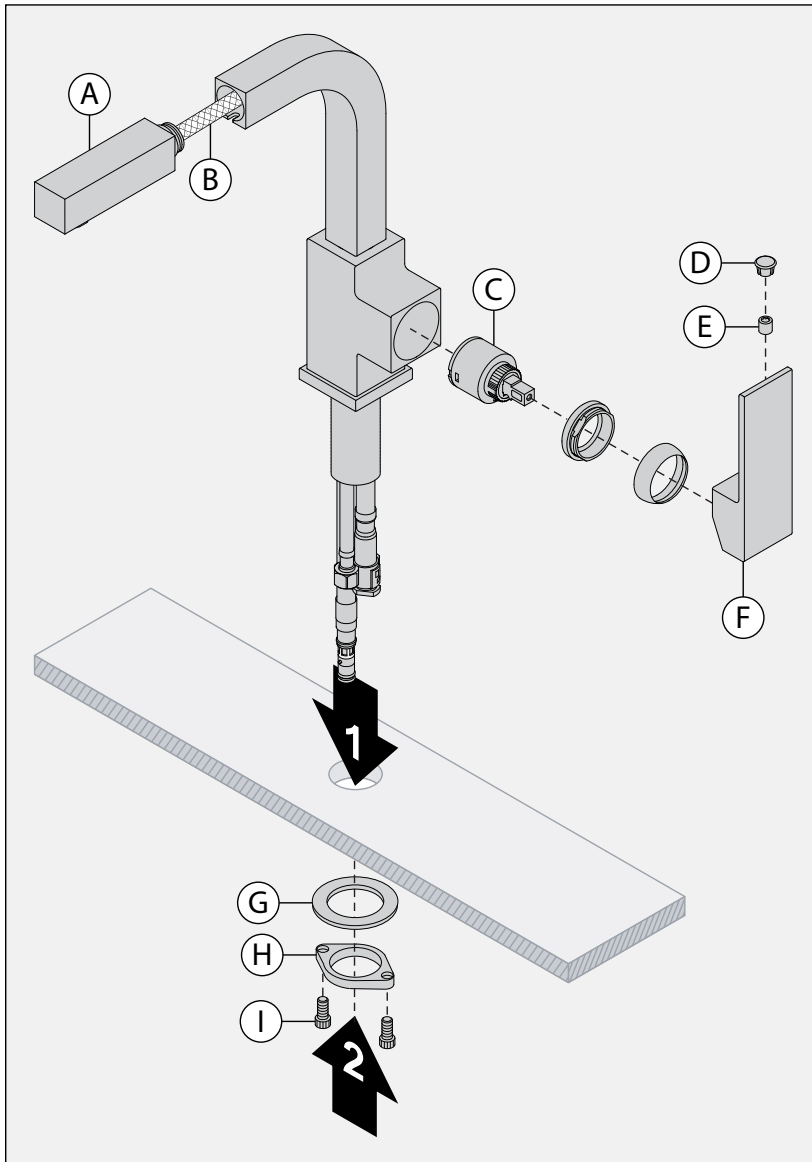
- 1) Hoses removed for clarity.
- 2) Dimensions subject to change without notice.

Parts Breakdown

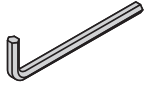
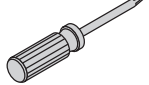

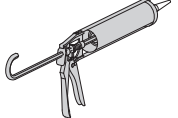
| Replacement Parts | | |
|----------------------------------|---|-------------|
| Item | Description | Part Number |
| A | Pull-Out Wand | RK-026 |
| B | Pull-Out Wand Hose | RK-032 |
| C | Cartridge | KN-4 |
| D | Plug Button | |
| E | Set Screw | RK-027 |
| F | Handle | |
| G | Mounting Washer | |
| H | Mounting Nut | RK-028 |
| I | Mounting Screws | |
| Tools Required for Installation | | |
| Adjustable Wrench |  | |
| Allen Wrench: Handle (2.5 mm) |  | |
| Phillips Head Screwdriver |  | |
| Plumber Tape |  | |
| Silicone |  | |

Notes:

- 1) Apply a bead of silicone around the perimeter of trim installed flush to sink.
- 2) Apply plumber tape to all threaded connections.

⚠ WARNING: This product can expose you to chemicals including lead, which is known to the state of California to cause cancer, birth defects, or other reproductive harm. For more information, go to www.P65Warnings.ca.gov.