

### Features

- Safeguard® slip-resistant finish for added safety.
- Single threshold for alcove installation with three tile-in flanges.
- Recessed drain (can be used with K-9155 or K-9156 drain cover).
- Right offset drain for easy 60" x 30" bath replacement.
- Ideal size for remodel installations into a 5-foot alcove with a shower door.
- Rim size optimized for water containment and aesthetics.

### Material

- KOHLER® enameled cast iron.

### Required Products/Accessories

K-9155 Drain Cover

or

K-9156 Drain Cover

### Recommended Products/Accessories

K-702206-G54 Frameless Sliding Shower Door  
K-702206-G73 Frameless Sliding Shower Door  
K-702206-L Frameless Sliding Shower Door  
K-702207-L Frameless Sliding Shower Door  
K-702217-L Frameless Sliding Shower Door  
K-705705-L Frameless Pivot Shower Door  
K-705711-L Frameless Pivot Shower Door  
K-705717-L Frameless Pivot Shower Door  
K-705723-L Frameless Pivot Shower Door  
K-705729-L Frameless Pivot Shower Door  
K-705741-L Frameless Pivot Shower Door  
K-705810-L Semi-Frameless Pivot Shower Door  
K-705811-L Semi-Frameless Pivot Shower Door  
K-705824-L Semi-Frameless Pivot Shower Door  
K-705825-L Semi-Frameless Pivot Shower Door  
K-706009-D3 Frameless Sliding Shower Door  
K-706009-L Frameless Sliding Shower Door  
K-706012-L Frameless Sliding Shower Door  
K-706013-L Frameless Sliding Shower Door  
K-706015-D3 Frameless Sliding Shower Door  
K-706015-L Frameless Sliding Shower Door  
K-706019-L Frameless Sliding Shower Door  
K-9132 Shower Drain



### Codes/Standards







ASME A112.19.1/CSA B45.2  
ASTM F462

### KOHLER® Enameled Cast Iron Bath and Shower Base Lifetime Limited Warranty

See website for detailed warranty information.

### Available Colors/Finishes

*Color tiles intended for reference only.*

Color	Code	Description
	0	White
	96	Biscuit
	47	Almond
	NY	Dune
	95	Ice™ Grey
	G9	Sandbar

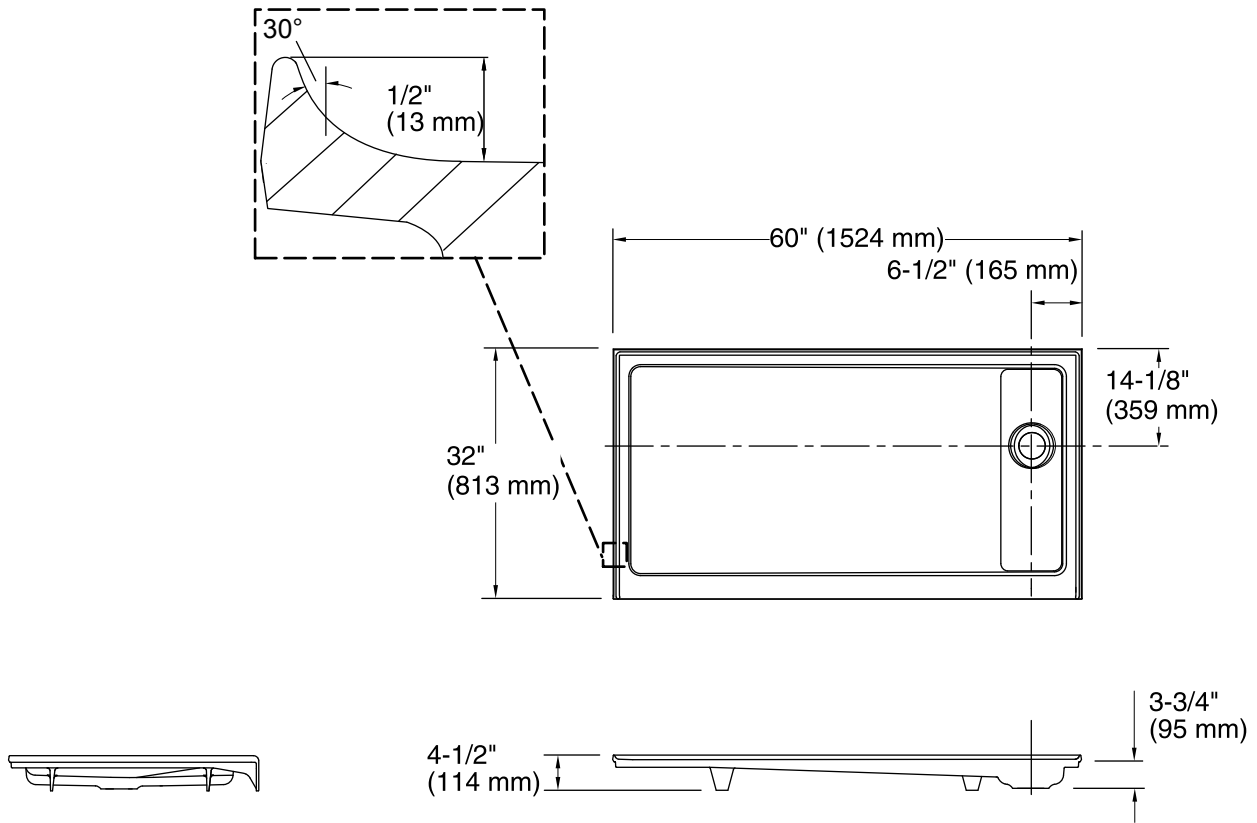

#### Technical Information

All product dimensions are nominal.

Installation: Three-wall alcove

Drain location: Right

Weight: 180 lbs (81.6 kg)

#### Notes

Measure your actual product for rough-in details.

Install this product according to the installation instructions.

The dimensions are applicable for this product only and should not be used to fabricate substitute bases for shower enclosures.

KOHLER steam generator/control kit is designed for use with this product. Kohler Co. shall not be responsible for problems encountered due to the installation and use of other manufacturer's steam generators.