

### Features

- Brass construction.
- One-piece, self-contained ceramic disc valve allows both volume and temperature control.
- Temperature memory allows faucet to be turned on and off at any temperature setting.
- High-temperature limit setting for added safety.
- Single-hole mounting.
- 6-1/4" (159 mm) spout reach.
- Straight handle.
- Touch-activated drain with tailpiece and no overflow.
- 1.2 gal/min (4.5 l/min) maximum flow rate [max at 60 psi (4.14 bar)].



### Codes/Standards

ASME A112.18.1/CSA B125.1

NSF/ANSI 61

NSF/ANSI 372

All applicable US Federal and State material regulations

DOE - Energy Policy Act 1992

EPA WaterSense®







California Energy Commission (CEC)

### KOHLER® Faucet Lifetime Limited Warranty

See website for detailed warranty information.

### Available Colors/Finishes

*Color tiles intended for reference only.*

Color	Code	Description
	CP	Polished Chrome
	SN	Vibrant® Polished Nickel
	AF	Vibrant® French Gold
	BGD	Vibrant® Moderne Brushed Gold
	BN	Vibrant® Brushed Nickel
	BV	Vibrant® Brushed Bronze
	BL	Matte Black
	RGD	Vibrant Rose Gold

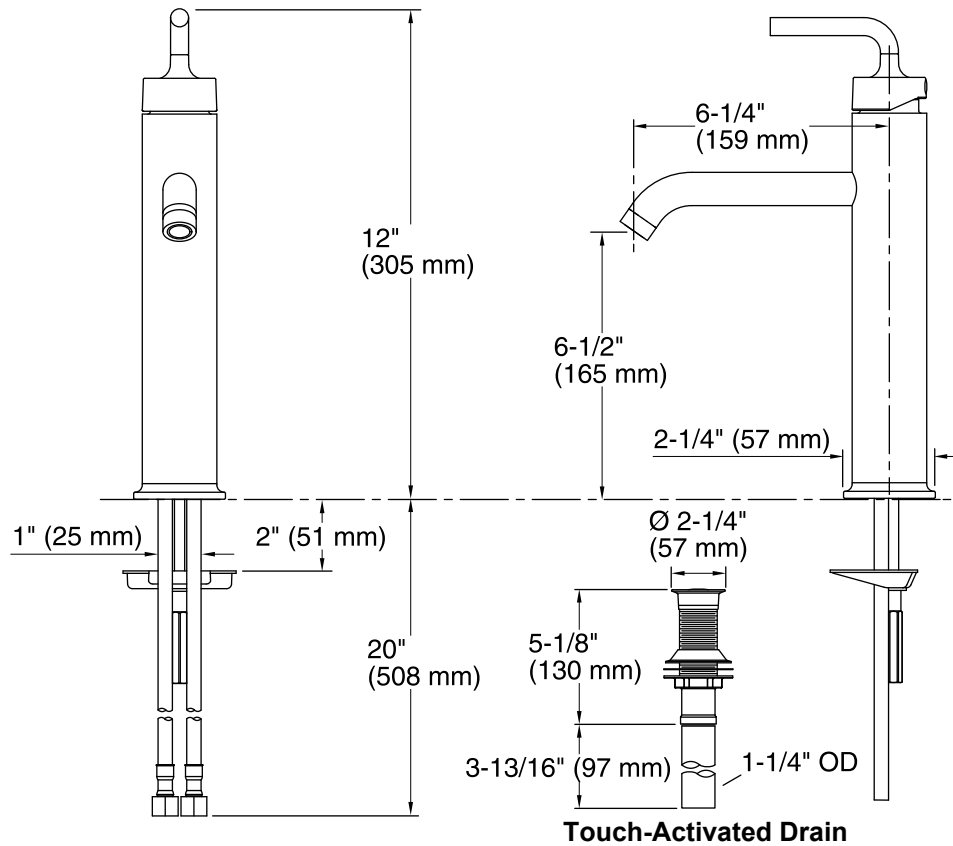

### Technical Information

All product dimensions are nominal.

#### Faucet:

Flow rate: 1.2 gal/min (4.5 l/min)

Pressure: 60 psi (4.1 bar)

Drain included: Yes

Drain tailpiece included: Yes

#### Spout:

Spout reach: 6-1/4" (159 mm)

### Notes

Install this product according to the installation guide.